







20 000 716

- hole diameter 32 mm
- rosette 60 x 60 mm
- with cold marking



Fits: CL.1, CYO

	Brushed Dark Platinum	20 000 716-99
	Chrome	20 000 716-00
	Brushed Platinum	20 000 716-06
	Dark Chrome	20 000 716-19
	Brushed Durabronze (23kt Gold)	20 000 716-28
	Brushed Champagne (22kt Gold)	20 000 716-46
	Champagne (22kt Gold)	20 000 716-47

20 000 716

mm [inches]



Flow rate chart



Certificates

IAPMO_4976 (1). LGA_28688.

20 000 716

Parts for other finishes can be found here: [Chrome](#)

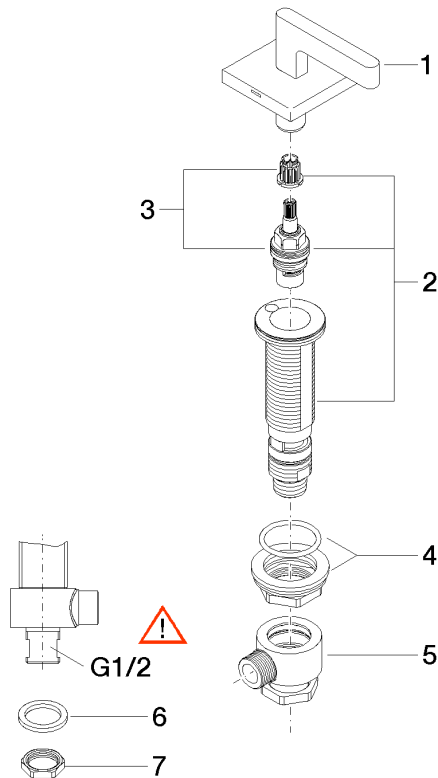

Spare parts list

No.	Item Number	Name	Quantity used	Delivery time
1	90 20 70 057 01-99	handle (cold)	1	30
2	04 17 11 058 32 90	side panel	1	2
3	90 90 03 132 00 90	top	1	2
4	04 23 10 032 78 90	fixing set	1	2
5	04 17 11 023 10 90	distributor	1	2
6	09 30 11 059 90	disc	1	2
7	09 23 10 012 90	nut	1	2